

# POTENTIOMETERS

## Cermet Trimming

**Beckman®**

- TO5 single turn
- 3/8" square single/multiple turn
- 3/4" rectangular – 15 turns

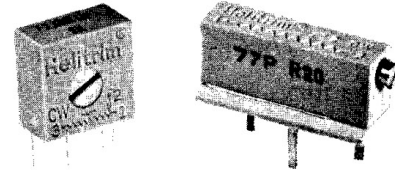

### INTRODUCTION

Helitrim® Cermet Trimming Potentiometers offer power resistance elements in small sizes and low cost in the following types together with mounting brackets for use with 78P and 89 series trimmers

### TECHNICAL DATA

Type	Description	Resistance Range	No. of Turns	Temperature Range	Power * Rating	Temp. Coefficient
62P 82P	1/4" dia. General Purpose low profile version (82P).	10Ω to 1MΩ	1	-25°C to +125°C	0.5 Watts at 70°C	±100 ppm/°C max.
68W	3/8" Square General Purpose	10Ω to 2MΩ	18	-55°C to +125°C	0.5 Watts at 70°C	±100 ppm/°C max.
72P 72PM 72X 72XW	3/8" single turn, low cost. Three mounting variations available.	10Ω to 2MΩ	1	-55°C to +105°C	0.5 Watts at 70°C	±100 ppm/°C max.
77P 79P	3/4" Rectangular sealed trimmer 79P low profile version.	10Ω to 2MΩ	15 15	-55°C to +125°C	0.75 Watts at 25°C	±100 ppm/°C max.
78P	1 1/4" Rectangular general purpose small size. Mounting bracket also available	10Ω to 2MΩ	22	-55°C to +105°C	1.0 Watts at 70°C	±100 ppm/°C max.
89P 89W	3/4" Rectangular, low cost, low profile mounting bracket also available	10Ω to 2MΩ	15	-55°C to +155°C	0.75 Watts at 25°C	±100 ppm/°C max. †

\*Derating to 0 at T°C max.  
†0 to 500 for 10 and 20 ohms, 0 to 250 for 50 ohms.

### OUTLINE DRAWINGS (All dimensions in inches)

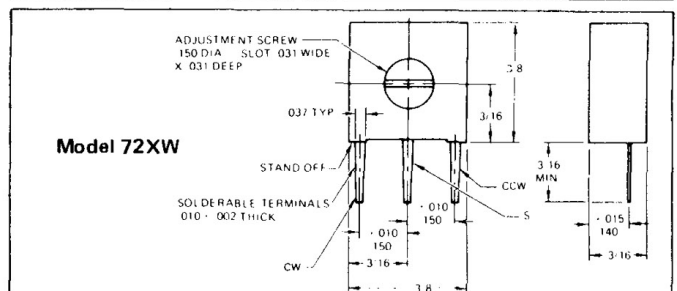
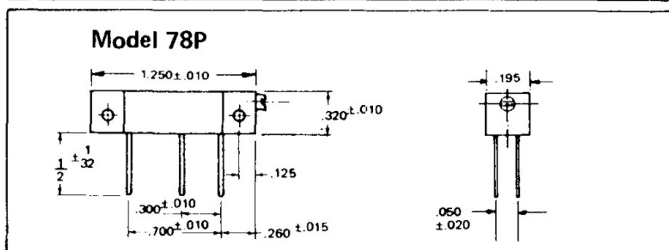
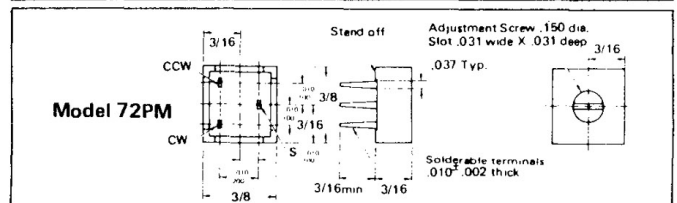
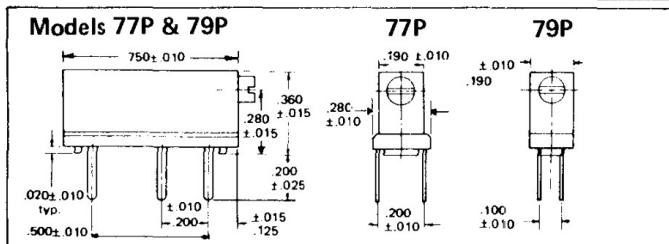
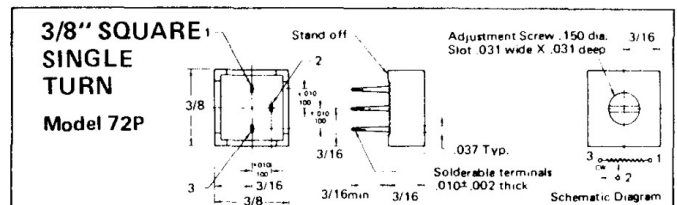
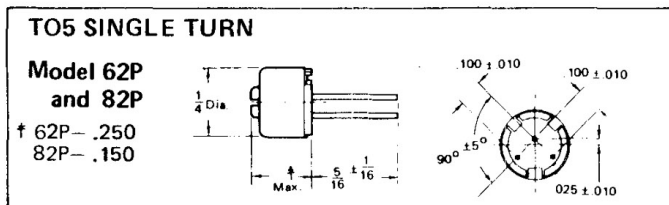

Manufactured in U.K.

- 1 1/4" Rectangular – 22 Turns
- Low Profile Trimmers
- Various Mountings Available

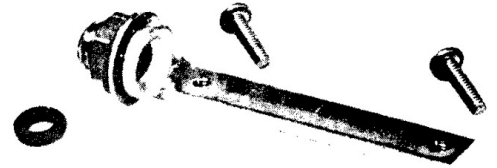
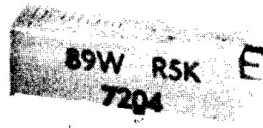

### STANDARD RESISTANCE VALUES, OHMS

10	100	1K	10K	100K	1M
20	200	2K	20K	200K	2M*
—	—	—	25K	250K	—
50	500	5K	50K	500K	—

\*Not available in Series 62P and 82P

### OUTLINE DRAWINGS

#### Model 72X

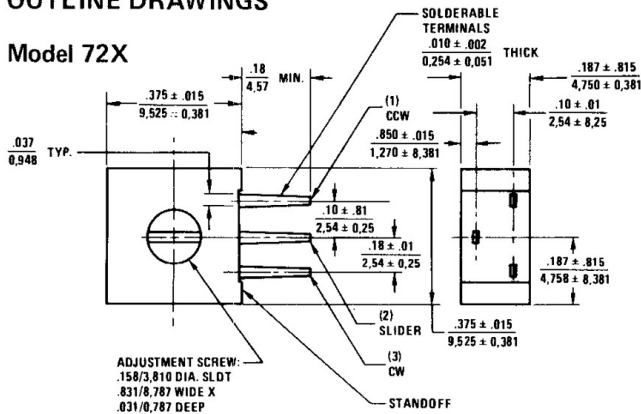

#### Model 68 W

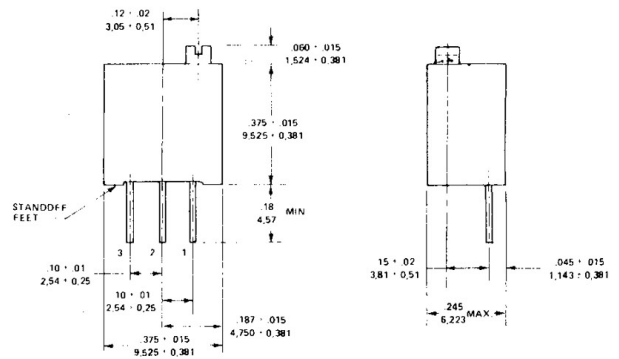

#### 56 BW Bushing Mount (for use with 78P)

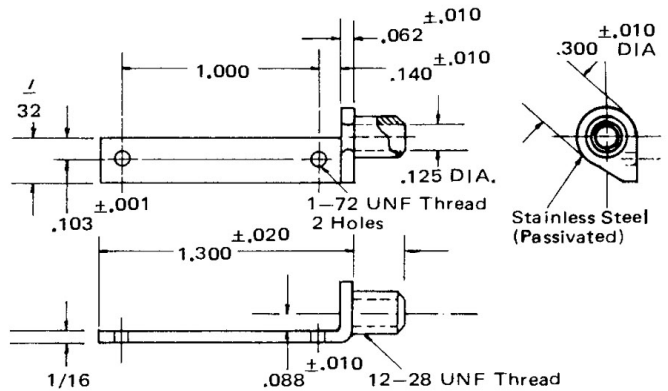

#### Model 89P

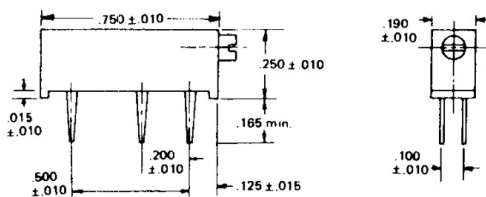

#### Model 89W

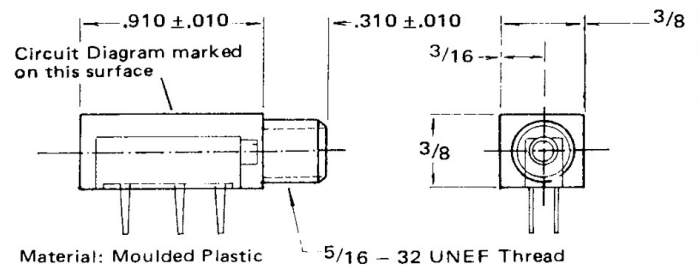
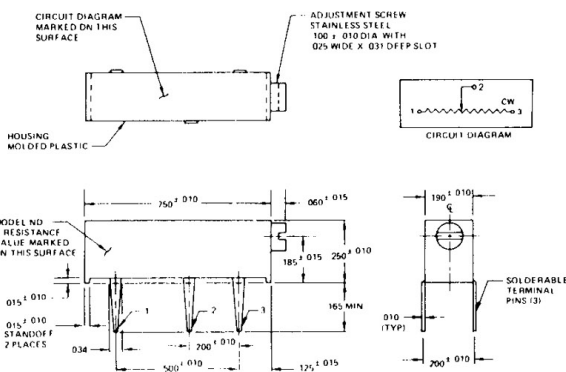

#### 89B Bushing Mount (for use with 89P/89W)

Manufactured in U.K.

All dimensions in inches