

μA78H00/μA78HG SERIES

5 AMP VOLTAGE REGULATOR FAIRCHILD LINEAR INTEGRATED CIRCUITS

μA78HGA

TP
10
KE

GENERAL DESCRIPTION

Fixed Output – The μA78H00 series hybrids are regulators with fixed output voltages and 5 A output current capability with all the inherent characteristics of the monolithic 3-terminal regulators, i.e., full thermal overload, short-circuit and safe-area protection. The μA78H00 is packaged in a hermetically sealed TO-3 providing 50 W power dissipation. The regulator consists of a monolithic chip driving a discrete series-pass element and two short-circuit detection transistors. A beryllium-oxide substrate is used in conjunction with an isothermal layout to optimize the thermal characteristics of the device and still maintain electrical isolation between the various chips. This unique circuit design limits the maximum junction temperature of the power output transistor to provide full automatic thermal overload protection. If the safe operating area is ever exceeded, the device simply shuts down, rather than failing or damaging other system components. This feature eliminates the need to design costly output circuitry and overly conservative heat sinking arrangements typical of high-current regulators built from discrete components.

Adjustable Regulators – The μA78HG is an adjustable 4-terminal positive voltage regulator capable of supplying in excess of 5 A over a 5.0 V to 24 V output range. The same features and construction details of the μA78H00 series have been incorporated into the μA78HG. Only two (2) external resistors are required to set the output voltage. Input and output capacitors should be used to improve input filtering and transient response.

- 5 A OUTPUT CURRENT
- INTERNAL CURRENT AND THERMAL LIMITING
- INTERNAL SHORT-CIRCUIT CURRENT LIMIT
- LOW DROP-OUT VOLTAGE
- 50 W POWER DISSIPATION

ABSOLUTE MAXIMUM RATINGS

Input Voltage	25 V
μA78H05, 12, 15	40 V
μA78HG	50 W @ 25°C Case
Internal Power Dissipation	25 V
Maximum Input-to-Output Voltage Differential	25 V
Operating Junction Temperature Range	
μA78H00C (fixed voltage series)	-0°C to 150°C
μA78HGC (adjustable voltage series)	-0°C to 150°C
Military Temperature Range (consult factory)	-55°C to 150°C
Storage Temperature Range	-55°C to 150°C
Lead Temperature (Soldering, 60 s)	300°C

CONNECTION DIAGRAMS TO-3 PACKAGE (TOP VIEW)

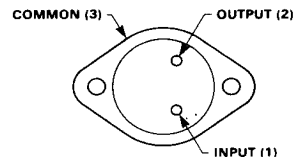

ORDER INFORMATION

OUTPUT VOLTAGE	TYPE	PART NO.
5.0 V	78H05C	μA78H05KC
12 V	78H12C	μA78H12KC
15 V	78H15C	μA78H15KC

TO-3 PACKAGE (TOP VIEW)

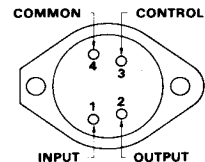

ORDER INFORMATION

OUTPUT VOLTAGE	TYPE	PART NO.
5-24 V	78HGC	μA78HGKC
Adjustable		

BLOCK DIAGRAM - FIXED OUTPUT 78H00 SERIES

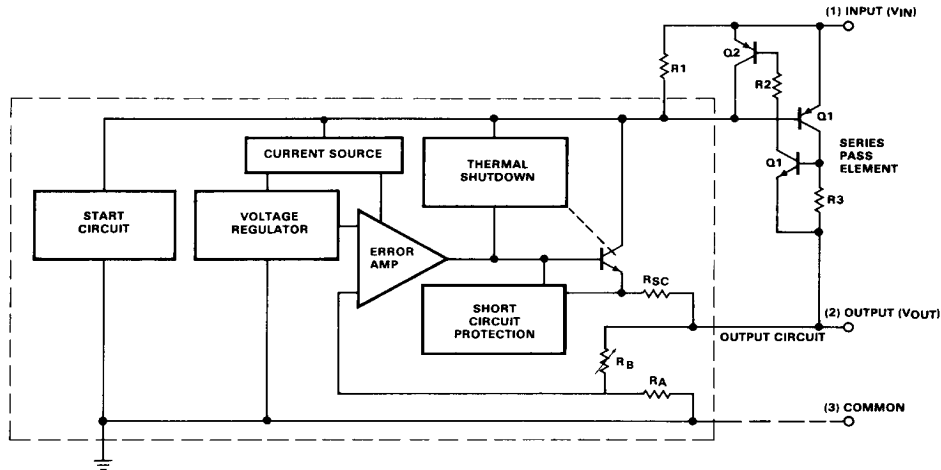

BLOCK DIAGRAM - ADJUSTABLE OUTPUT 78HG

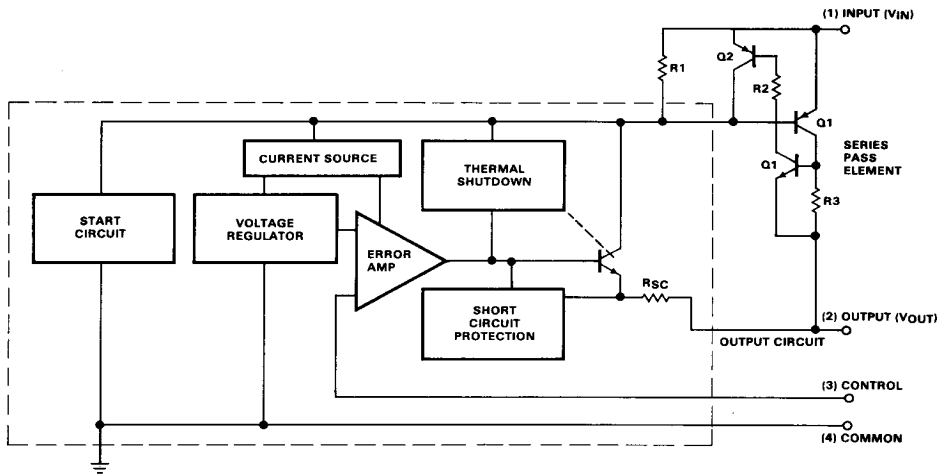

ELECTRICAL CHARACTERISTICS: $T_J = 25^\circ\text{C}$, $I_{OUT} = 2.0\text{ A}$ unless otherwise specified.

CHARACTERISTICS	CONDITIONS	μ A78H05C			UNITS
		MIN	TYP	MAX	
Output Voltage	$I_{OUT} = 2.0\text{ A}$, $V_{IN} = 10\text{ V}$	4.8	5.0	5.2	V
Line Regulation (Note 1)	$V_{IN} = 8.5\text{ to }25\text{ V}$		10	50	mV
Load Regulation (Note 1)	$10\text{ mA} \leq I_{OUT} \leq 5.0\text{ A}$, $V_{IN} = 10\text{ V}$		10	50	mV
Quiescent Current	$I_{OUT} = 0$, $V_{IN} = V_{OUT} + 5.0\text{ V}$			10	mA
Ripple Rejection	$I_{OUT} = 1.0\text{ A}$, $f = 210\text{ Hz}$, 5.0 V P-P	60			dB
Output Noise	$10\text{ Hz} \leq f \leq 100\text{ kHz}$, $V_{IN} = V_{OUT} + 5.0\text{ V}$		40		μVRMS
Dropout Voltage	$I_O = 5.0\text{ A}$		3.0		V
	$I_O = 3.0\text{ A}$		2.6		V
Short Circuit Current Limit	$V_{IN} = 10\text{ V}$		7.0		A_{pk}

ELECTRICAL CHARACTERISTICS: $T_J = 25^\circ\text{C}$, $I_{OUT} = 2.0\text{ A}$ unless otherwise specified.

CHARACTERISTICS	CONDITIONS	μ A78H12C			UNITS
		MIN	TYP	MAX	
Output Voltage	$I_{OUT} = 2.0\text{ A}$, $V_{IN} = 19\text{ V}$	11.5	12	12.5	V
Line Regulation (Note 1)	$V_{IN} = 16\text{ to }25\text{ V}$		20	120	mV
Load Regulation (Note 1)	$10\text{ mA} \leq I_{OUT} \leq 5.0\text{ A}$, $V_{IN} = 19\text{ V}$		20	120	mV
Quiescent Current	$I_{OUT} = 0$, $V_{IN} = V_{OUT} + 5.0\text{ V}$			10	mA
Ripple Rejection	$I_{OUT} = 1.0\text{ A}$, $f = 210\text{ Hz}$, 5.0 V P-P	60			dB
Output Noise	$10\text{ Hz} \leq f \leq 100\text{ kHz}$, $V_{IN} = V_{OUT} + 5.0\text{ V}$		75		μVRMS
Dropout Voltage	$I_O = 5.0\text{ A}$		3.0		V
	$I_O = 3.0\text{ A}$		2.6		V
Short Circuit Current Limit	$V_{IN} = 19\text{ V}$		7.0		A_{pk}

1.9999"

ELECTRICAL CHARACTERISTICS: $T_J = 25^\circ\text{C}$, $I_{OUT} = 2.0\text{ A}$ unless otherwise specified.

CHARACTERISTICS	CONDITIONS	μ A78H15C			UNITS
		MIN	TYP	MAX	
Output Voltage	$I_{OUT} = 2.0\text{ A}$, $V_{IN} = 20\text{ V}$	14.4	15	15.6	V
Line Regulation (Note 1)	$V_{IN} = 19\text{ to }25\text{ V}$		30	150	mV
Load Regulation (Note 1)	$10\text{ mA} \leq I_{OUT} \leq 5.0\text{ A}$, $V_{IN} = 20\text{ V}$		30	150	mV
Quiescent Current	$I_{OUT} = 0$, $V_{IN} = V_{OUT} + 5.0\text{ V}$			10	mA
Ripple Rejection	$I_{OUT} = 1.0\text{ A}$, $f = 210\text{ Hz}$, 5.0 V P-P	60			dB
Output Noise	$10\text{ Hz} \leq f \leq 100\text{ kHz}$, $V_{IN} = V_{OUT} + 5.0\text{ V}$		75		μVRMS
Dropout Voltage	$I_O = 5.0\text{ A}$		3.0		V
	$I_O = 3.0\text{ A}$		2.6		V
Short Circuit Current Limit	$V_{IN} = 20\text{ V}$		7.0		A_{pk}

ELECTRICAL CHARACTERISTICS: $T_J = 25^\circ\text{C}$, $I_{OUT} = 2.0\text{ A}$ unless otherwise specified.

CHARACTERISTICS	CONDITIONS	μ A78HG (Adjustable)			UNITS (Note 2)
		MIN	TYP	MAX	
Output Voltage	$I_{OUT} = 2.0\text{ A}$, $V_{IN} = V_{OUT} + 3.5\text{ V}$	5.0	Note 3	24	V
Line Regulation (Note 1)	$V_{IN} = 8.5\text{ to }25\text{ V}$			1%	V_{OUT}
Load Regulation (Note 1)	$10\text{ mA} \leq I_{OUT} \leq 5.0\text{ A}$, $V_{IN} = 10\text{ V}$			1%	V_{OUT}
Quiescent Current	$I_{OUT} = 0$, $V_{IN} = V_{OUT} + 5.0\text{ V}$			10	mA
Ripple Rejection	$I_{OUT} = 1.0\text{ A}$, $f = 210\text{ Hz}$, 5.0 V P-P	60			dB
Output Noise	$10\text{ Hz} \leq f \leq 100\text{ kHz}$, $V_{IN} = V_{OUT} + 5.0\text{ V}$		50		μVRMS
Dropout Voltage	$I_O = 5.0\text{ A}$		3.0		V
	$I_O = 3.0\text{ A}$		2.6		V
Short Circuit Current Limit	$V_{IN} = 10\text{ V}$		7.0		A_{pk}
Control Pin Voltage	$V_{IN} = 10\text{ V}$	4.8	5.0	5.2	V

NOTES:

- Load and line regulation are specified at constant junction temperature. Pulse testing is required with a pulse width $\leq 1\text{ ms}$ and a duty cycle $\leq 5\%$. Full Kelvin connection methods must be used to measure these parameters.
- The performance characteristics of the adjustable series (μ A78HG) is specified for $V_{OUT} = 5.0\text{ V}$.
- V_{OUT} for (μ A78HG) is defined as $V_{OUT} = \frac{R1 + R2}{R2} (V_{CONT})$

BASIC TEST CIRCUITS

μ A78H00 SERIES
FIXED OUTPUT VOLTAGE

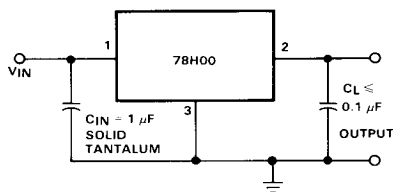

μ A78HG
ADJUSTABLE OUTPUT VOLTAGE

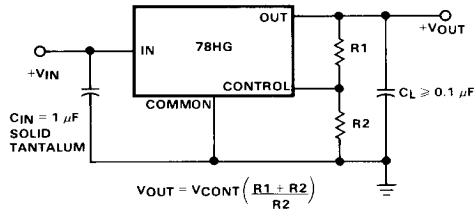

TYPICAL PERFORMANCE CHARACTERISTICS

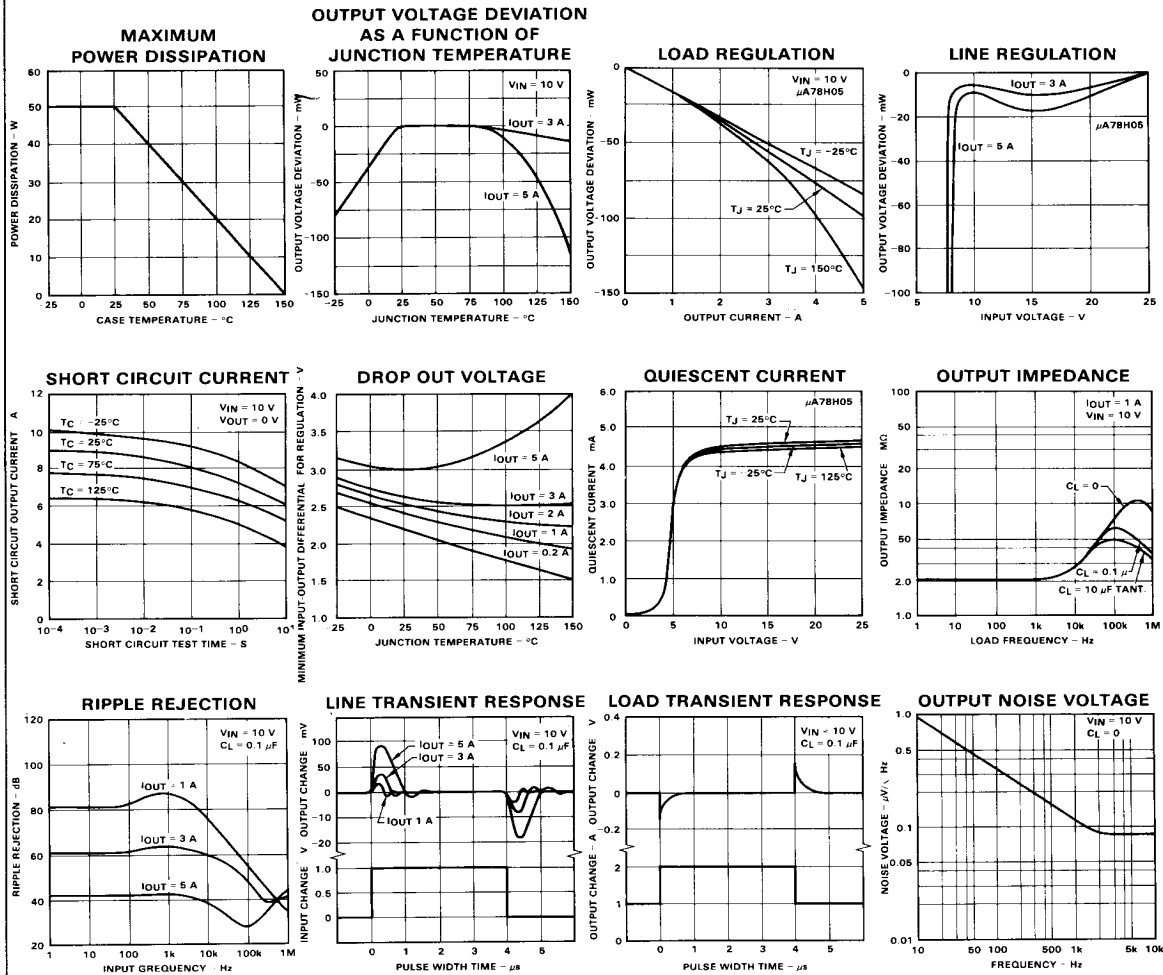

7

DESIGN CONSIDERATIONS

78H00 Series – The μ A78H00 fixed voltage regulator series has thermal overload protection from excessive power, internal short circuit protection which limits the circuit's maximum current, and output transistor safe area compensation to prevent excessive instantaneous power appearing across the pass transistor as the voltage across it increases. Thus, the device is fully protected from all overload abnormalities.

78HG Series – The μ A78HG variable voltage regulator has an output voltage which varies from $V_{CONTROL}$ to typically $V_{IN} - 3.0$ V by $V_{OUT} = V_{CONTROL} (R1 + R2)/R2$. The nominal reference in the μ A78HG is 5.0 V. If we allow 1.0 mA to flow in the control string to eliminate bias current effects, we can make $R2 = 5$ k Ω in the μ A78HG. The output voltage is then: $V_{OUT} = (R1 + R2) V$, where $R1$ and $R2$ are in k Ω s.

Example: If $R2 = 5$ k Ω and $R1 = 10$ k Ω then $V_{OUT} = 15$ V nominal, for the μ A78HG.

By proper wiring of the feedback resistors, load regulation of the devices can be improved significantly.

The regulators have thermal overload protection from excessive power, internal short circuit protection which limits each circuit's maximum current, and output transistor safe area protection to prevent excessive instantaneous power appearing across the pass transistor as the voltage across it increases. Thus the device is fully protected from all overload abnormalities.

Although the internal power dissipation is limited, the junction temperature must be kept below the maximum specified temperature (125°C) in order to meet data sheet specifications. To calculate the maximum junction temperature or heat sink required, the following thermal resistance values should be used:

PACKAGE	TYP θ_{JC}	MAX θ_{JC}	TYP θ_{JA}	MAX θ_{JA}
TO-3	2.0	2.5	32	38

$$P_{D(MAX)} = \frac{T_J(MAX) - T_A}{\theta_{JC} + \theta_{CA}} \text{ or } \frac{T_J(MAX) - T_A}{\theta_{JA}}$$

$$\theta_{CA} = \theta_{CS} + \theta_{SA}$$

Solving for T_J : $T_J = T_A + P_D (\theta_{JC} + \theta_{CA})$ or $T_A + P_D \theta_{JA}$ (Without heat sink)

Where:

T_J = Junction Temperature

T_A = Ambient Temperature

P_D = Power Dissipation

θ_{JC} = Junction to case thermal resistance

θ_{CA} = Case to ambient thermal resistance

θ_{CS} = Case to heat sink thermal resistance

θ_{SA} = Heat sink to ambient thermal resistance

θ_{JA} = Junction to ambient thermal resistance

TYPICAL APPLICATIONS FOR μ A78H00/78HG SERIES

In many applications, compensation capacitors may not be required. However, for stable operation of the regulator over all input voltage and output current ranges, bypassing of the input and output (1.0 μ F solid tantalum and 0.1 μ F respectively) is recommended. Input bypassing is necessary if the regulator is located far from the filter capacitor of the power supply. Bypassing the output will improve the transient response of the regulator.

