

MINIATURE PC BOARD RELAY

FEATURES

- Subminiature size
- High sensitivity, 110mW pickup
- Coils to 48VDC
- Hermetically sealed version available
- Epoxy sealed for automatic wave soldering
- Withstands 4kV standard IEEE Lightning Surge
- Withstands 6kV IEEE Lightning Surge (special order)
- Class B insulation (130°C) standard
- Class F insulation (155°C) version available
- UL, CUR file E44211
- VDE approved versions available (Class A Insulation only)



CONTACTS

Arrangement	SPDT (1 Form C) SPST (1 Form A)
Ratings Light Duty	Resistive load: Max. switched power: 100W or 600VA Max. switched current: 3A Max. switched voltage: 150VDC or 300VAC UL Rating: See chart on Page 3
Medium Duty	Max. switched power: 180W or 1800VA Max. switched current: 6A Max. switched voltage: 150VDC or 300VAC UL Rating: See chart on Page 3
Material	Light duty: Silver Medium duty: Silver nickel
Resistance	< 100 milliohms initially

COIL

Power At Pickup Voltage (typical)	Standard coil: 250mW (48V coil: 341mW) Sensitive coil: 175mW (48V coil: 182mW)
Max. Continuous Dissipation	Class B: 2.0W 20°C (68°F) ambient 1.6W 40°C (104°F) ambient Class F: 2.5W 20°C (68°F) ambient 2.1W 40°C (104°F) ambient
Temperature Rise	At nominal coil voltage Standard coil: 38°C (68°F) Sensitive coil: 28°C (50°F)
Temperature	Max. 105°C (221°F) Class A Max. 130°C (266°F) Class B Max. 155°C (311°F) Class F

GENERAL DATA

Life Expectancy Mechanical Electrical Light Duty Medium Duty	Minimum operations 1 x 10 ⁷ 3 x 10 ⁵ at 3A, 120VAC 1.8 x 10 ⁵ at 6A, 120VAC
Operate Time (typical)	5ms at nominal coil voltage
Release Time (typical)	2ms at nominal coil voltage (with no coil suppression)
Dielectric Strength (at sea level for 1 min.)	750Vrms contact to contact 2000Vrms contact to coil except hermetically sealed version which is 1600Vrms
Insulation Resistance	1000 megohms min. at 20°C, 500VDC, 50% RH
Dropout	Greater than 5% of nominal coil voltage
Ambient Temperature Operating Storage	At nominal coil voltage -55°C (-67°F) to 90°C (194°F) Class B -55°C (-67°F) to 115°C (239°F) Class F -55°C (-67°F) to 130°C (266°F) Class B -55°C (-67°F) to 155°C (311°F) Class F
Vibration	0.062" DA at 10–55 Hz, 10 g at 55–110 Hz
Shock	10g
Enclosure	P.E.T. polyester
Terminals	Tinned copper alloy, P.C.
Max. Solder Temp.	270°C (518°F)
Max. Solder Time	5 seconds
Max. Solvent Temp.	80°C (176°F)
Max. Immersion Time	30 seconds
Weight	Approx. 11 grams

NOTES

1. All values at 20°C (68°F).
2. Relay may pull in with less than "Must Operate" value.
3. Other coil resistances and sensitivities available upon request.
4. Unsealed relays should not be dip cleaned.
5. Specifications subject to change without notice.

RELAY ORDERING DATA

COIL SPECIFICATIONS				ORDER NUMBER*			
STANDARD RELAYS: 1 Form C (SPDT)				LIGHT DUTY (3 Amp contact)		MEDIUM DUTY (6 Amp contact)	
Nominal Coil VDC	Max. VDC Continuous	Resistance $\pm 10\%$	Must Operate VDC	Unsealed	Epoxy Sealed	Unsealed	Epoxy Sealed
5	10.6	56	3.75	AZ8-1C-5D	AZ8-1C-5DE	AZ8-1CH-5D	AZ8-1CH-5DE
6	12.6	80	4.50	AZ8-1C-6D	AZ8-1C-6DE	AZ8-1CH-6D	AZ8-1CH-6DE
9	19.0	180	6.75	AZ8-1C-9D	AZ8-1C-9DE	AZ8-1CH-9D	AZ8-1CH-9DE
12	25.0	320	9.00	AZ8-1C-12D	AZ8-1C-12DE	AZ8-1CH-12D	AZ8-1CH-12DE
18	37.8	720	13.50	AZ8-1C-18D	AZ8-1C-18DE	AZ8-1CH-18D	AZ8-1CH-18DE
24	50.0	1,280	18.00	AZ8-1C-24D	AZ8-1C-24DE	AZ8-1CH-24D	AZ8-1CH-24DE
48	87.0	3,800	36.00	AZ8-1C-48D	AZ8-1C-48DE	AZ8-1CH-48D	AZ8-1CH-48DE
SENSITIVE RELAYS: 1 Form C (SPDT)				LIGHT DUTY (3 Amp contact)		MEDIUM DUTY (6 Amp contact)	
Nominal Coil VDC	Max. VDC Continuous	Resistance $\pm 10\%$	Must Operate VDC	Unsealed	Epoxy Sealed	Unsealed	Epoxy Sealed
5	12.6	80	3.75	AZ8-1C-5DS	AZ8-1C-5DSE	AZ8-1CH-5DS	AZ8-1CH-5DSE
6	14.8	110	4.50	AZ8-1C-6DS	AZ8-1C-6DSE	AZ8-1CH-6DS	AZ8-1CH-6DSE
9	22.4	250	6.75	AZ8-1C-9DS	AZ8-1C-9DSE	AZ8-1CH-9DS	AZ8-1CH-9DSE
12	30.0	440	9.00	AZ8-1C-12DS	AZ8-1C-12DSE	AZ8-1CH-12DS	AZ8-1CH-12DSE
24	60.0	1,780	18.00	AZ8-1C-24DS	AZ8-1C-24DSE	AZ8-1CH-24DS	AZ8-1CH-24DSE
48	120.0	7,120	36.00	AZ8-1C-48DS	AZ8-1C-48DSE	AZ8-1CH-48DS	AZ8-1CH-48DSE

* Substitute "1A" or "1AH" in place of "1C" or "1CH" to indicate 1 Form A contact. To indicate Class F version, add suffix "F". For Hermetically sealed version, substitute "H" for "E". When suffix "E" is specified for Epoxy Seal, refer to AZ "Relay Technical Notes" on AZ website - Product Resources. Consult factory for other PCB process conditions that may apply.

RELAY ORDERING DATA - VDE APPROVED VERSIONS

COIL SPECIFICATIONS				ORDER NUMBER	
STANDARD RELAYS: 1 Form C (SPDT) – VDE				MEDIUM DUTY	
Nominal Coil VDC	Max. VDC Continuous	Resistance $\pm 10\%$	Must Operate VDC	Unsealed 6 Amp	Epoxy Sealed 5 Amp
5	10.6	56	3.75	AZ8-1CH-5DA	AZ8-1CH-5DEA
6	12.6	80	4.50	AZ8-1CH-6DA	AZ8-1CH-6DEA
9	19.0	180	6.75	AZ8-1CH-9DA	AZ8-1CH-9DEA
12	25.0	320	9.00	AZ8-1CH-12DA	AZ8-1CH-12DEA
24	50.0	1,280	18.00	AZ8-1CH-24DA	AZ8-1CH-24DEA
48	87.0	3,800	36.00	AZ8-1CH-48DA	AZ8-1CH-48DEA
SENSITIVE RELAYS: 1 Form C (SPDT) – VDE				MEDIUM DUTY	
Nominal Coil VDC	Max. VDC Continuous	Resistance $\pm 10\%$	Must Operate VDC	Unsealed 6 Amp	Epoxy Sealed 5 Amp
5	12.6	80	3.75	AZ8-1CH-5DSA	AZ8-1CH-5DSEA
6	14.8	110	4.50	AZ8-1CH-6DSA	AZ8-1CH-6DSEA
9	22.4	250	6.75	AZ8-1CH-9DSA	AZ8-1CH-9DSEA
12	30.0	440	9.00	AZ8-1CH-12DSA	AZ8-1CH-12DSEA
24	60.0	1,780	18.00	AZ8-1CH-24DSA	AZ8-1CH-24DSEA
48	120.0	7,120	36.00	AZ8-1CH-48DSA	AZ8-1CH-48DSEA

* Substitute "1AH" in place of "1CH" to indicate 1 Form A contact.

UL, CUR RATINGS

Light Duty	2A at 28VDC or 300VAC 1/8 HP at 120 VAC 1/10 HP at 120/240 VAC (100,000 cyc) 1.2/0.6 A at 120/240 VAC, Pilot Duty 100,000 cyc 3.0/1.5 A at 120/240 VAC General Use 100,000 cyc
Medium Duty	6A at 28VDC or 300VAC 1/8 HP at 120/240 VAC (100,000 cyc) 1.5/0.8 A at 120/240 VAC, Pilot Duty 100,000 cyc 3.8/1.9 A at 120/240 VAC General Use 100,000 cyc

VDE RATINGS

Sealed	5A at 250VAC resistive, 10,000 cycles
Unsealed	6A at 250VAC resistive, 50,000 cycles

MECHANICAL DATA

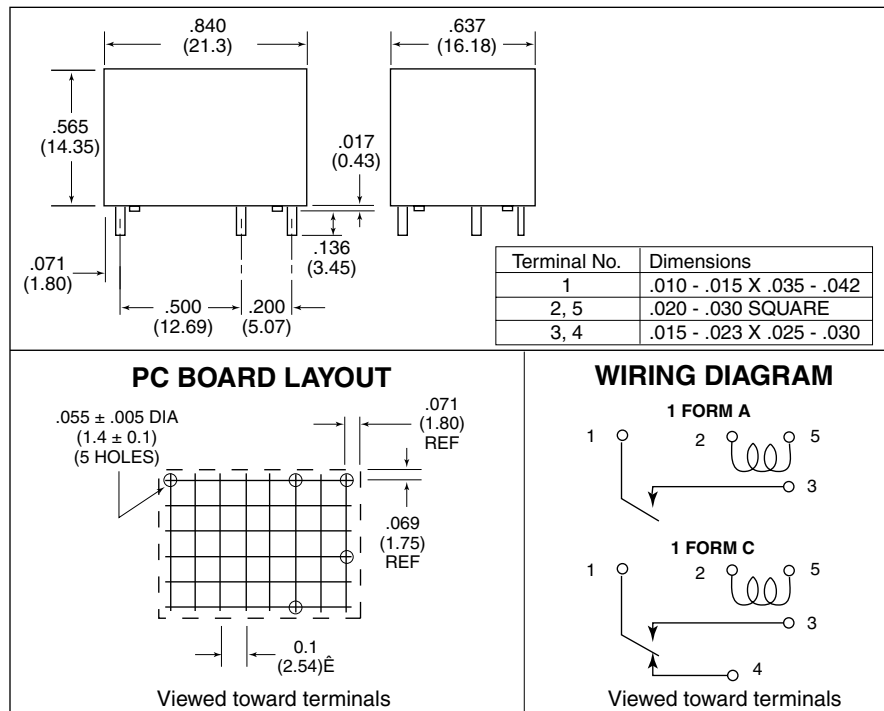

Dimensions in inches with metric equivalents in parentheses. Tolerance: ± .010"

Coil Temperature Rise

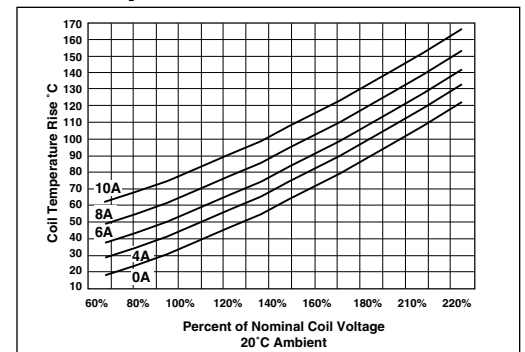

Maximum Switching Capacity

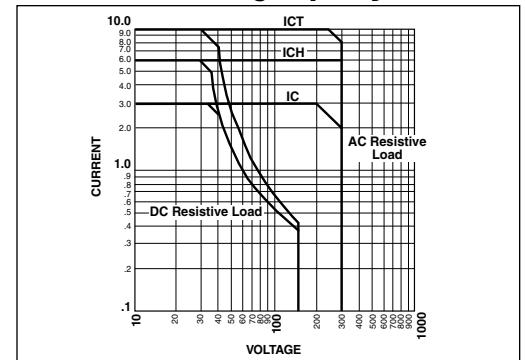

HERMETICALLY SEALED VERSION



MECHANICAL DATA

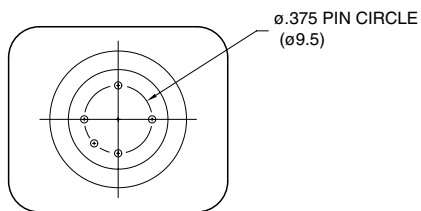
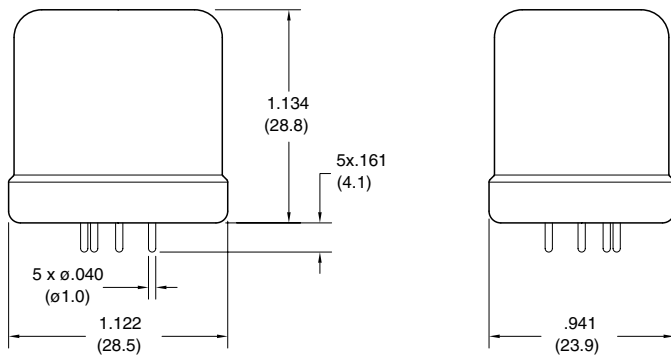

PC BOARD LAYOUT

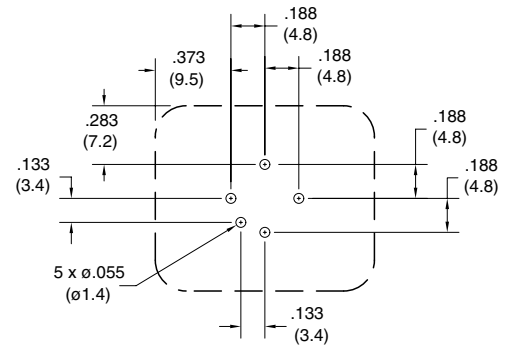

VIEWED TOWARD TERMINALS

WIRING DIAGRAMS

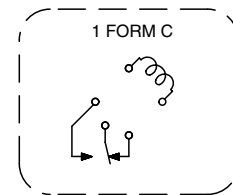
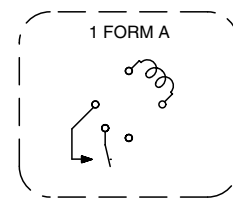

VIEWED TOWARD TERMINALS